

EN SKID PLATE INSTALLATION MANUAL

DE MONTAGEEINLEITUNG FÜR UNTERBODENSCHUTZSYSTEM

RU ИНСТРУКЦИЯ ПО УСТАНОВКЕ КОМПЛЕКТА ЗАЩИТ



For: Polaris Ranger 900/1000 (2018-)

2444.7448.1

444.7448.1



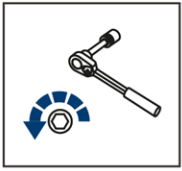

EN Regular fasteners
DE Originale montageteile
RU Штатный крепеж

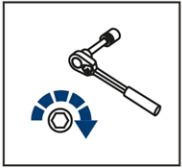

EN Regular fasteners
DE Originale montageteile
RU Штатный крепеж



EN Screw a several turns
DE Für wenigen Umdrehungen befestigen
RU Вкрутить на несколько оборотов



EN Loosen bolts
DE Bolzen lockern
RU Выкрутить на несколько оборотов

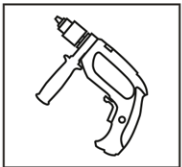

EN Drill
DE Bohrer
RU Дрель

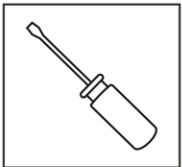

EN Screwdriver
DE Schraubenzieher
RU Отвертка

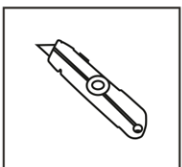

EN Office Knife
DE Büromesser
RU Канцелярский нож



EN Ratchet
DE Ratsche
RU Трещётка

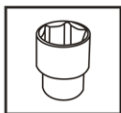



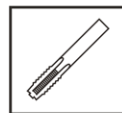



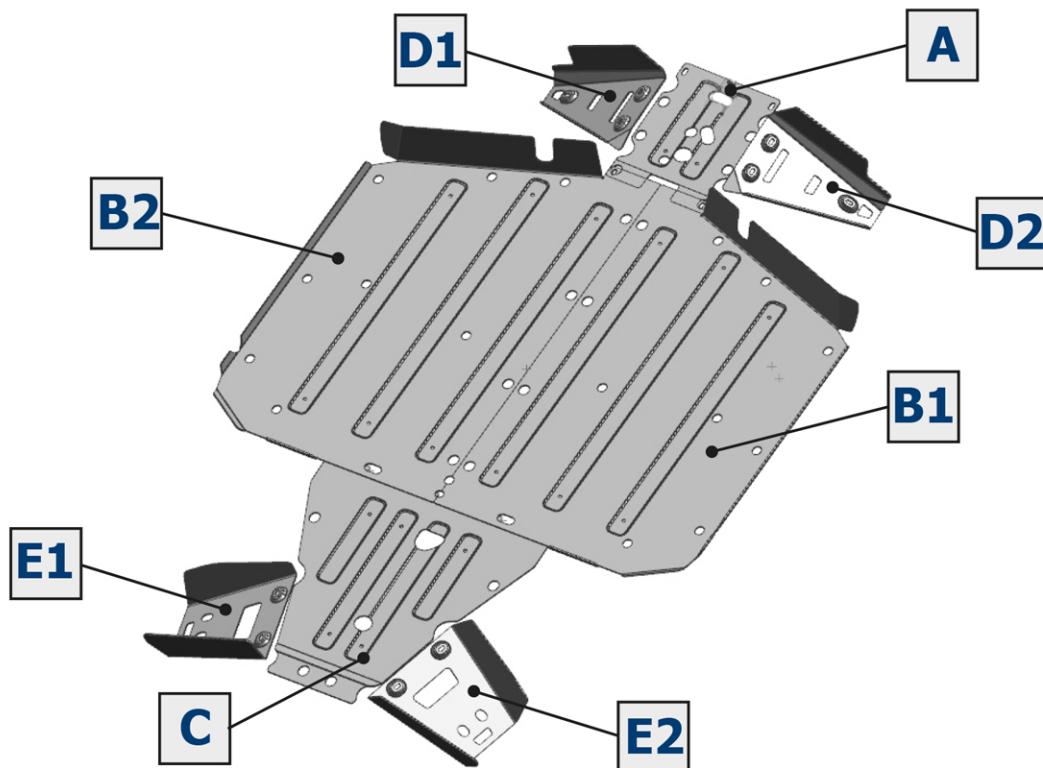

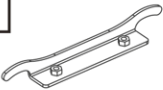

S - 10;
S - 13



M6

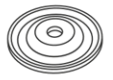

1	 x2	2	 x2	3	 x2	4	 x4	5	 x2	6	 M8x60/30 x10
7	 M6x25 x22	8	 M8x25 x32	9	 Ø8 x10	10	 Ø6 x22	11	 Ø8 x22		

