

EN	SKID PLATE INSTALLATION MANUAL
FR	MANUEL D'INSTALLATION DE PLAQUE DE PROTECTION
DE	MONTAGEEINLEITUNG FÜR UNTERBODENSCHUTZSYSTEM
RU	ИНСТРУКЦИЯ ПО УСТАНОВКЕ КОМПЛЕКТА ЗАЩИТ



**For: Yamaha Kodiak (2016-)**

**2444.7132.1**

**444.7132.1**



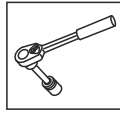



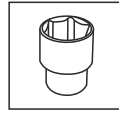



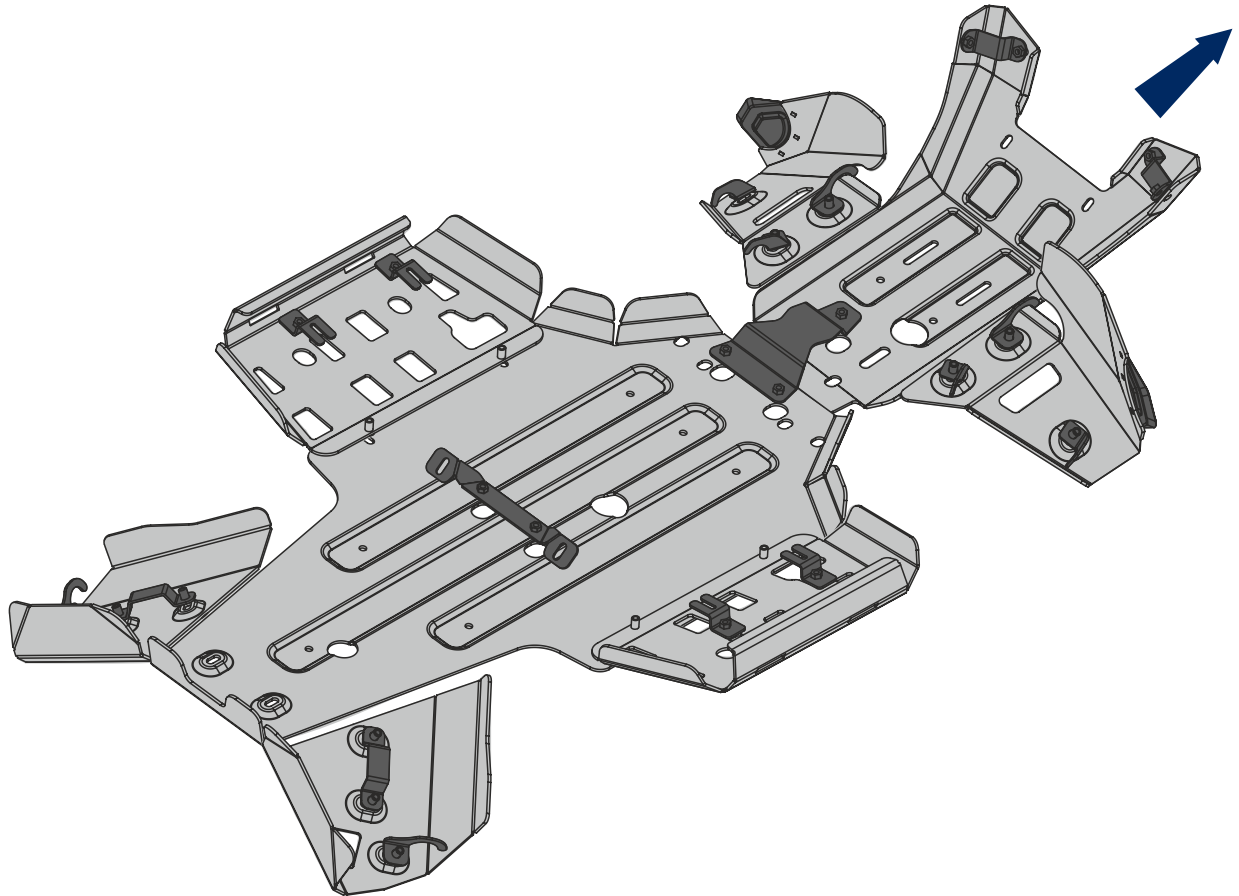

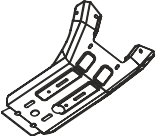
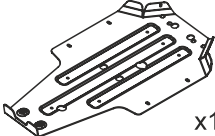
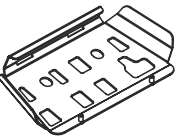
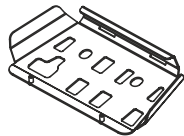
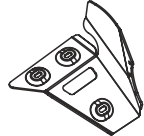

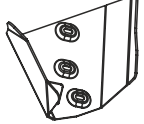
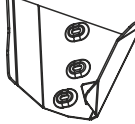
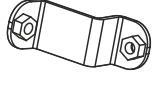
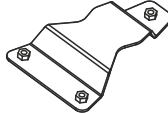
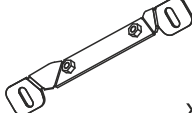
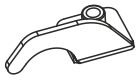
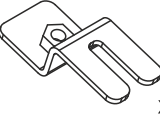
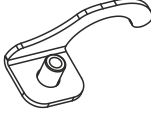
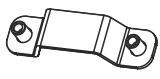
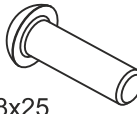
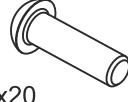
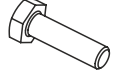
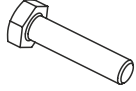
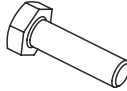
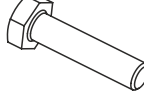
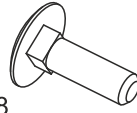

EN Ratchet  
FR Clé À Cliquet  
DE Ratsche  
RU Трещетка

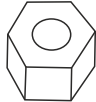



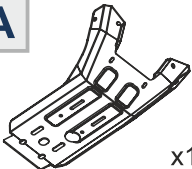
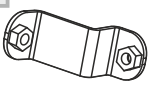
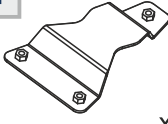



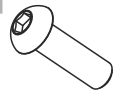
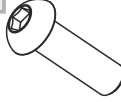
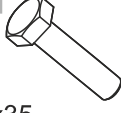

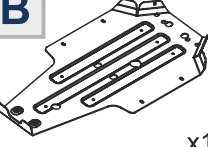
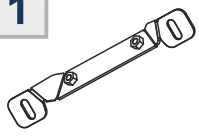
S - 10;  
S - 13



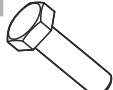

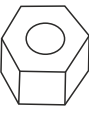

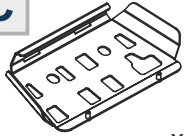
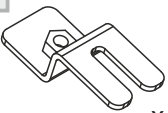
 x1	 x1	 x1	 x1	 x1	 x1
 x1	 x1	 x2	 x1	 x1	 x4
 x4	 x4	 x2	 M8x25 x8	 M6x20 x2	 M6x20 x4
 M6x30 x2	 M8x25 x18	 M8x35 x3	 $\varnothing 8$ x6	 $\varnothing 8$ x9	 $\varnothing 6$ x6
 $\varnothing 6$ x16	 $\varnothing 8$ x22	 M6 x8	 x1	 x1	

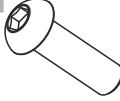
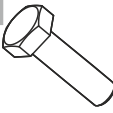

<b>A</b>  x1	<b>1</b>  x2	<b>2</b>  x1	<b>3</b>  Ø8 x1	<b>4</b>  Ø6 x2	<b>5</b>  Ø8 x4
	<b>6</b>  M6x20 x2	<b>7</b>  M8x25 x4	<b>8</b>  M8x35 x1		



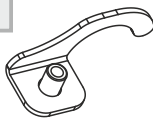

<b>B</b>  x1	<b>1</b>  x1	<b>2</b>  M6x20 x4	<b>3</b>  M6x30 x2	<b>4</b>  M8x25 x2	<b>5</b>  M8x35 x2
	<b>6</b>  Ø6 x8	<b>7</b>  Ø8 x4	<b>8</b>  M6 x2		

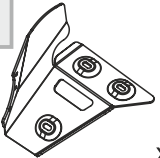
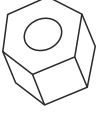
<b>C</b>  x1	<b>1</b>  x4	<b>2</b>  Ø8 x4	<b>3</b>  Ø8 x4	<b>4</b>  M8x25 x4	<b>5</b>  M8x25 x4

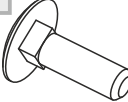
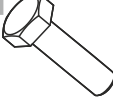
<b>D</b>  x1					
---	--	--	--	--	--

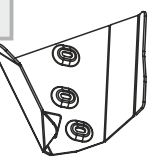
<b>E</b>  x1	<b>1</b>  x1	<b>2</b>  x1	<b>3</b>  x2	<b>4</b>  x4	<b>5</b>  Ø6 x6

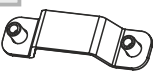
<b>F</b>  x1	<b>6</b>  M6 x6	<b>7</b>  Ø6 x6	<b>8</b>  Ø8 x6	<b>9</b>  x6	<b>10</b>  M8x25 x6

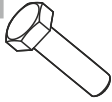
<b>G</b>  x1	<b>1</b>  x2	<b>2</b>  x2	<b>3</b>  Ø8 x6	<b>4</b>  M8x25 x6	

<b>H</b>  x1					
---	--	--	--	--	--

