

EN FOOTWELL PROTECTION INSTALLATION MANUAL

DE MONTAGEEINLEITUNG FÜR UNTERBODENSCHUTZSYSTEM

RU ИНСТРУКЦИЯ ПО УСТАНОВКЕ КОМПЛЕКТА ЗАЩИТ



**For: CForce UForce 1000 EPS (2019-)**

2444.6898.1;  
444.6898.1



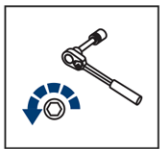

EN Regular fasteners  
DE Originale montageteile  
RU Штатный крепеж



EN Regular fasteners  
DE Originale montageteile  
RU Штатный крепеж



EN Screw a several turns  
DE Für wenigen Umdrehungen befestigen  
RU Вкрутить на несколько оборотов



EN Loosen bolts  
DE Bolzen lockern  
RU Выкрутить на несколько оборотов

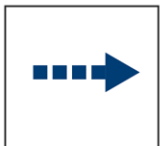

EN Movement Arrow  
DE Bewegungsrichtung  
RU Движение







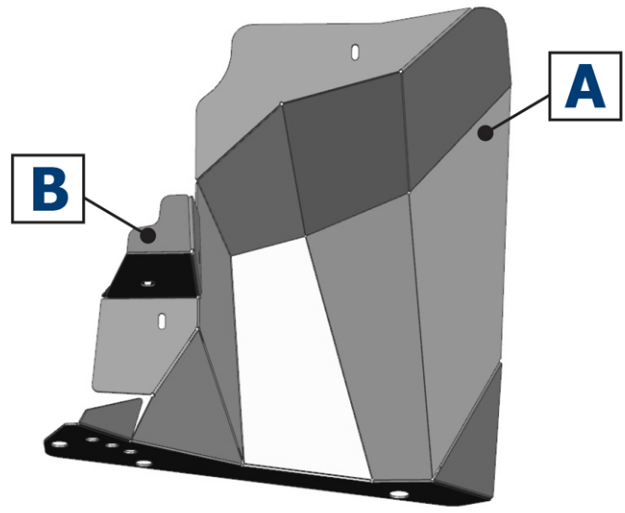
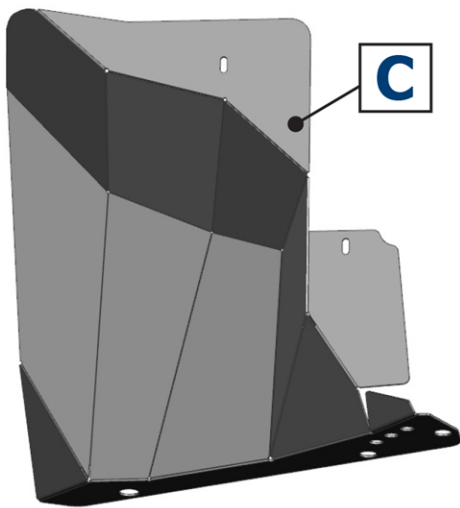

EN Location/Position Arrow  
DE Anordnung/Positionsrichtung  
RU Расположение

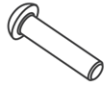

EN Screw Arrow  
DE Drehungsrichtung  
RU Поворот



<b>1</b>  M6x25 x4	<b>2</b>  M8x25 x2	<b>3</b>  M8x25 x6	<b>4</b>  Ø8 x12	<b>5</b>  Ø6 x4	<b>6</b>  Ø8 x2
<b>7</b>  M8 x6					

